

MIL-STD-1553 Transformers

Low profile 3.3V Pulse Transformers.
Ruggedized

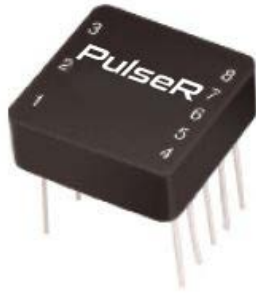

- Ⓡ Dual ratio in a single transformer package (see Schematic)
- Ⓡ Operating and Storage Temperature: -55 °C to +125 °C
- Ⓡ Weight: ≤5.0 grams
- Ⓡ Applicable specifications
 - n MIL-STD-1553B
 - n MIL-STD-202
 - n MIL-PRF-21038
 - n ISO 9001

Ⓡ Maximum Re-flow Temperature for SMT parts: 235°C

Electrical Specifications @ 25°C

Part Number	Terminals	Ratio (±3%)	DC Resistance (Ω MAX)	Impedance (Ω MIN)	Drop	Overshoot	CMR	Frequency Range (No Load)	IR @ 250Vdc (MIN)	DWV
Q1553-70	1-3:4-8 1-3:5-7	1.0CT:3.0CT 1.0CT:2.15CT	1-3 = 0.35 4-8 = 3.50	4-8 4000	20% MAX	±1V MIN	45db MIN	75kHz to 1MHz	10KMΩ	100 Vrms
SMQ1553-70	1-3:4-8 1-3:5-7	1CT:3CT 1CT:2.15CT	(1-3) .35 (4-8) 3.5	4-8 4000	20% max	±1V MAX	45dB MIN	75kHz to 1MHz	10KMΩ	100 Vrms
GL1553-71	1-3:4-8 1-3:5-7	1CT:3.54CT 1CT:2.50CT	(1-3) 0.35 (4-8) 3.5	4-8 4000	20% max	±1V MAX	45dB MIN	75kHz to 1MHz	10KMΩ	100 Vrms
DGL1553-71	1-3:1613/5-7:12-9 1-3:15-14/5-7:11-10	1CT:3.54CT 1CT:2.5CT	(1-3),(5-7) 0.35 (16-13),(12-9)3.5	16-13&12-9 4000	20% max	±1V MAX	45dB MIN	75kHz to 1MHz	10KMΩ	100 Vrms
TQ1553-71	1-3:4-8 1-3:5-7	1CT:3.54CT 1CT:2.5CT	(1-3) 0.35 (4-8) 3.5	4-8 4000	20% max	±1V MAX	45dB MIN	75kHz to 1MHz	10KMΩ	100 Vrms

Mechanical

Schematic

Q1553-70

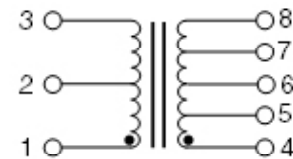
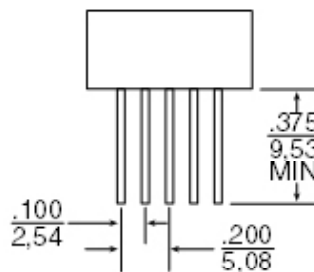
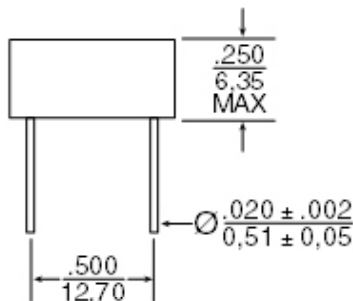
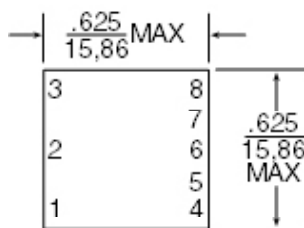

Notes:

1. All dimensions are in inches.
2. Tolerances: .xx = +.008
3. All specifications and dimensions are subject to change without notice.
4. MSL - 1
5. Tube - 20 pieces

MIL-STD-1553 Transformers

Low profile 3.3V Pulse Transformers.
Ruggedized



Mechanical

Schematic

SMQ1553-70

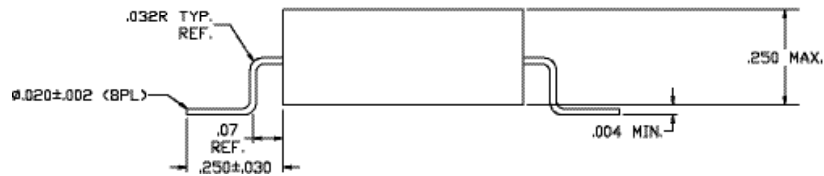
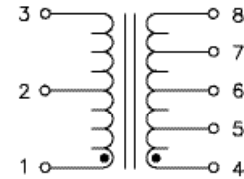
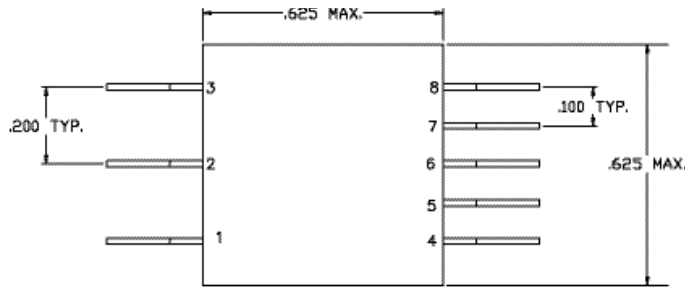

Notes:

1. All dimensions are in inches.
2. Tolerances: .xx = +.008
3. All specifications and dimensions are subject to change without notice.
4. MSL – 3
5. Tape & Reel Size – 300

Mechanical

Schematic

GL1553-71

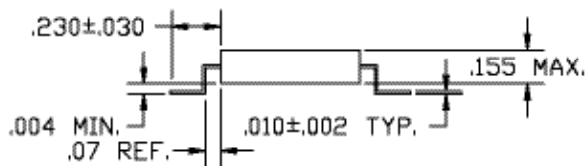
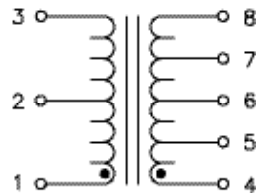
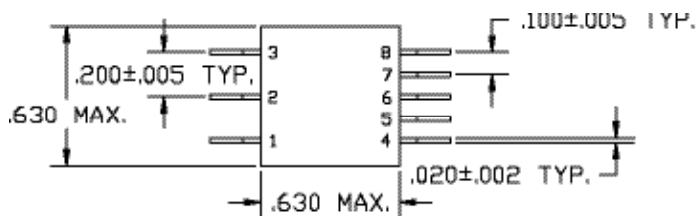

Notes:

1. All dimensions are in inches.
2. Tolerances: .xx = +.008
3. All specifications and dimensions are subject to change without notice.
4. MSL – 3
5. Tape & Reel Size – 350

MIL-STD-1553 Transformers

Low profile 3.3V Pulse Transformers.
Ruggedized



Mechanical

Schematic

DGL1553-71

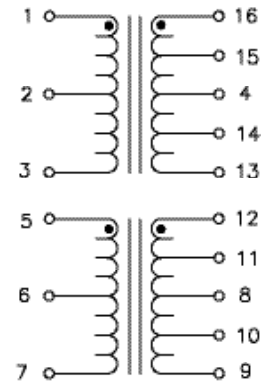
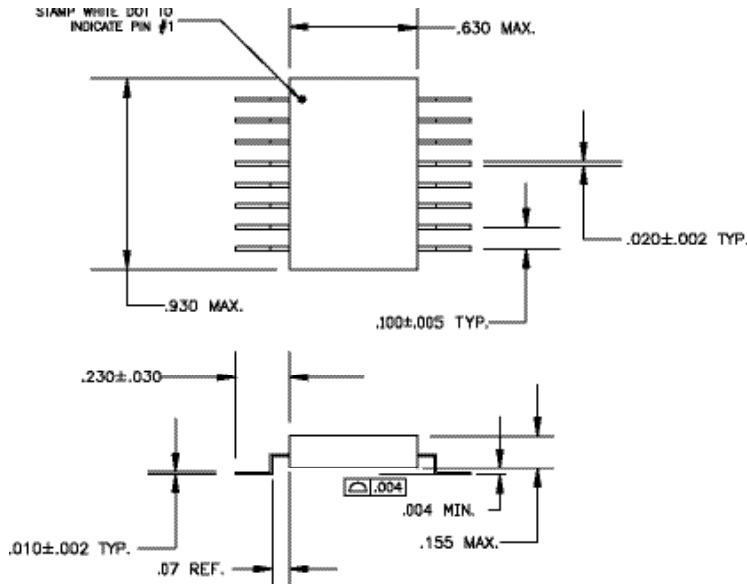

Notes:

1. All dimensions are in inches.
2. Tolerances: .xx = +.008
3. All specifications and dimensions are subject to change without notice.
4. MSL - 3
5. Tape & Reel Size - 300

Mechanical

Schematic

TQ1553-71

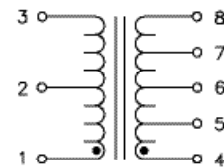
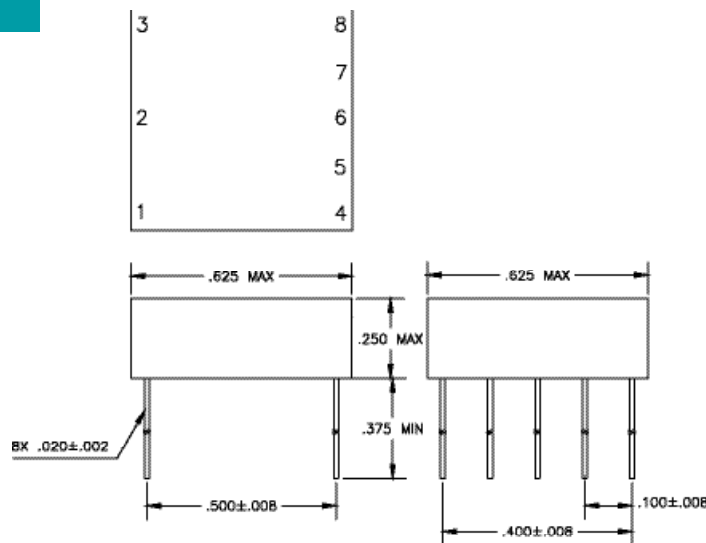

Notes:

1. All dimensions are in inches.
2. Tolerances: .xx = +.008
3. All specifications and dimensions are subject to change without notice.
4. MSL - 1
5. Tube - 20 pieces

For More Information

PulseR North America
Headquarters
Two Pearl Buck Court
Bristol, PA 19007
U.S.A.

Tel: +1.215.781.6400
Fax: +1.215.781.6403

For Global Sales Representatives and Locations Visit:
<http://www.pulseruggedized.com>

Performance warranty of products offered on this data sheet is limited to the parameters specified. Data is subject to change without notice. Other brand and product names mentioned herein may be trademarks or registered trademarks of their respective owners. © Copyright, 2018. PulseR, LLC. All rights reserved.