

- R** Compliant with ANSI X3T111, Fiber Channel, FC-PH-3 for quarter/full speed applications, SMPTE, IEEE1394 Firewire
- R** Moisture sensitivity Level : 3
- R** Pick and place compatible
- R** Peak temperature profile 250°C; NL parts peak temperature is 245°C
- R** AS9100 Certified (Based on and including ISO 9001:2000)

### Electrical Specifications @ 25°C — Operating Temperature -55°C to +125°C

Part Number	Turns Ratio (±5%)	Primary Inductance (µH MIN)	Rise Time @ 20% to 80% (pS MAX)	DC Resistance (Ω MAX)	Hi-Pot (Vrms MIN)	Insertion Loss (dB MAX)	Application Nominal Bit Rate (Mbaud)
T-330SCT	1CT:1CT	26 @ 1Vrms, 100kHz	350	0.2	1,500	-1.5 @ 15-165MHz	265.6 (1/4 speed)
T-531SCT	1CT:1CT	7.5@1Vrms, 100kHz	325	0.2	1,500	-2.0 @ 50-265MHz	531 (half speed)
T-1062SCT	1CT:1CT	3.75@1Vrms, 100kHz	280	0.2	1,500	-2.0 @ 100-531MHz	1,062.5 (full speed)
T-1250SCT	1CT:1CT	3.75@1Vrms, 100kHz	280	0.2	1,500	-2.0@125-650MHz	1,250
T-1485SCT	1CT:1CT	3.75@1Vrms, 100kHz	270	0.2	1,500	-2.0	1,485 (SMTPE)
T-3200SCT	1:1	0.70	200	0.2	1,500	-4.5	3,200

#### NOTES:

- To order a RoHS compliant part, add the suffix "NL" to the part number, i.e. T-330SCT becomes T-330SCTNL.
- Add suffix "T" to part number for Tape & Reel package (i.e. T-330SCTT).

### Mechanical

### Schematic

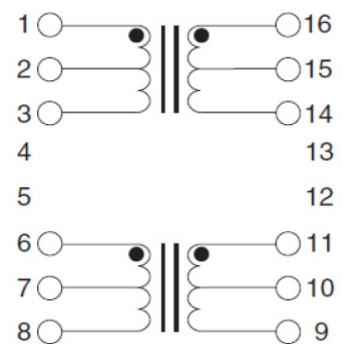
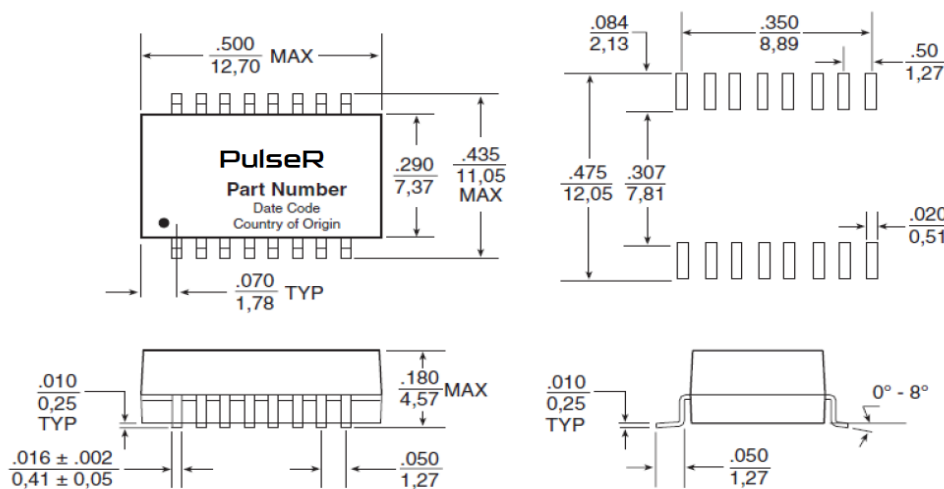

Weight .....1.0 grams  
 Tape & Reel ..... 400/reel  
 Dimensions:  $\frac{\text{Inches}}{\text{mm}}$   
 Unless otherwise specified,  
 all tolerances are  $\pm \frac{.005}{0,13}$

## Mechanical

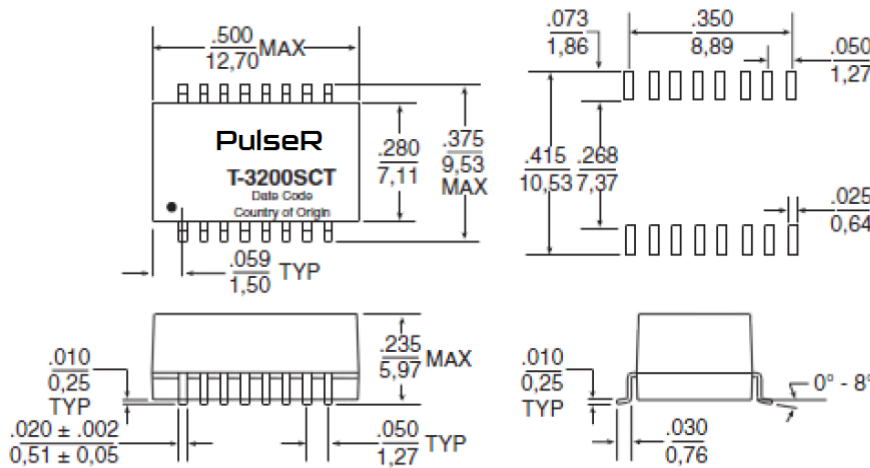

## Schematic

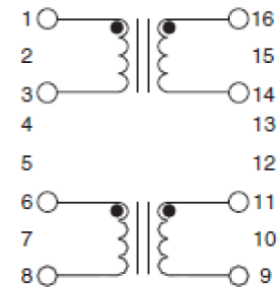

Weight ..... 1.0 grams  
 Tape & Reel ..... 600/reel  
 Dimensions: Inches  
 mm  
 Unless otherwise specified,  
 all tolerances are ± .005  
 0,13

## Application

Pulse Specialty Components has designed Fibre Channel dual transformers specifically for point to point coupling to 150 twinax cable. The isolation transformers protect the station from static charges that may develop on the cable, and prevents ground loop currents from being transferred between stations. The devices have also been designed to provide common mode rejection within the transmission band and thus reduce EMI. The wide bandwidth of these

devices minimizes data dependent jitter by providing fast signal rise times. Low-end bandwidth also minimizes base-line wander, another contributor to jitter. The dual package allows connection of both transmit and receive channels, as shown in the application circuit below. Surface-mount packaging also allows a cost-effective solution.

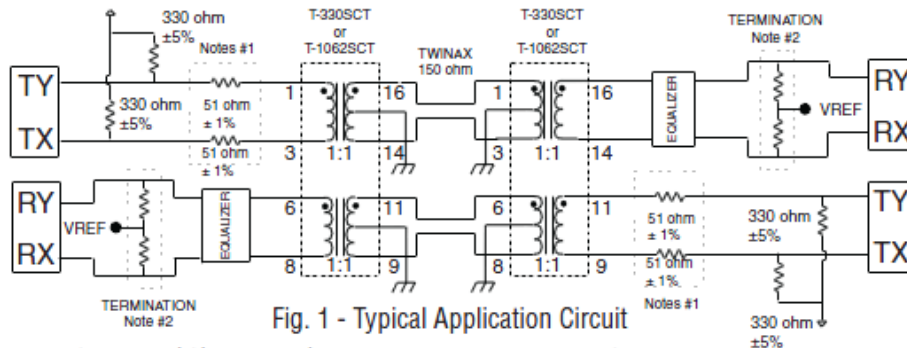
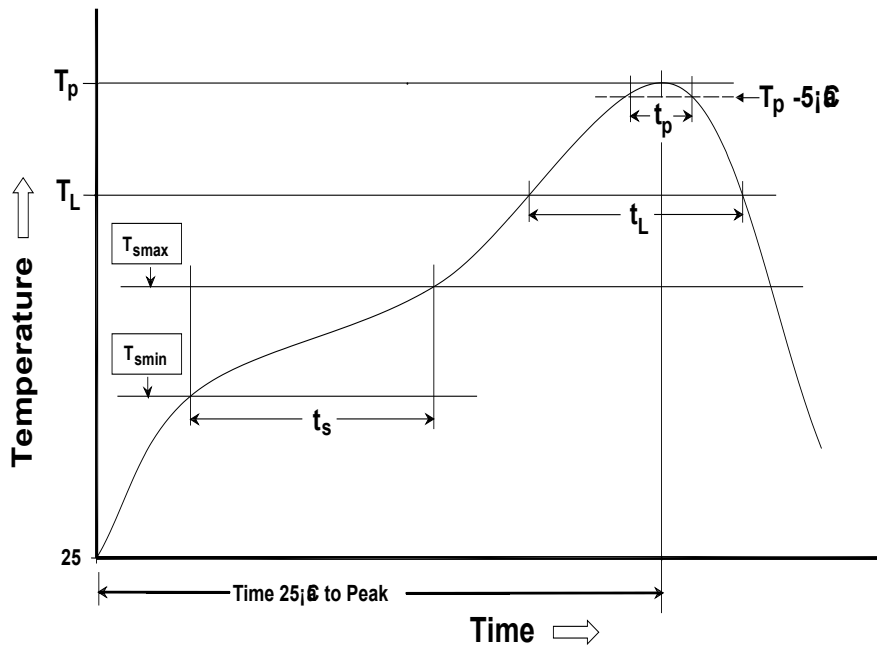

Fig. 1 - Typical Application Circuit

1. The transformer, 51 Ω resistors, and the impedance of the driver are matched to achieve the best return loss (S11) for the transmitter of the 150 Ω system.
2. The total impedance of termination resistor network is 150 Ω.
3. When laying out PCB, transmission line methods must be utilized to maintain return loss and signal integrity. Transformer must be located within .50 of the DB9

4. It is recommended that the center tap (CT) of transformer(s), cable side, be connected to earth/chassis (cable shield) ground either directly or via a transient voltage suppressor (TVS) type component and earth/chassis ground should be "AC-coupled" to signal (digital) ground through a 0.27uF, 500v capacitor.

No Lead Recommended Reflow Profile (Based on J-STD-020D)



$T_{SMIN}$ (°C)	$T_{SMAX}$ (°C)	$T_L$ (°C)	$T_P$ (°C MAX)	$t_s$ (s)	$t_L$ (s)	$t_p$ (s MAX)	Ramp-up rate ( $T_L$ to $T_P$ )	Ramp-down rate ( $T_P$ to $T_L$ )	Time 25°C to peak temperature (s MAX)
150	200	217	245	60-120	60-150	30	3°C/s MAX	6°C/s MAX	480

Notes:

1. All temperatures measured on the package leads.
2. Maximum times of reflow cycle: 2.

Tin/Lead Recommended Reflow Profile (Based on J-STD-020D)

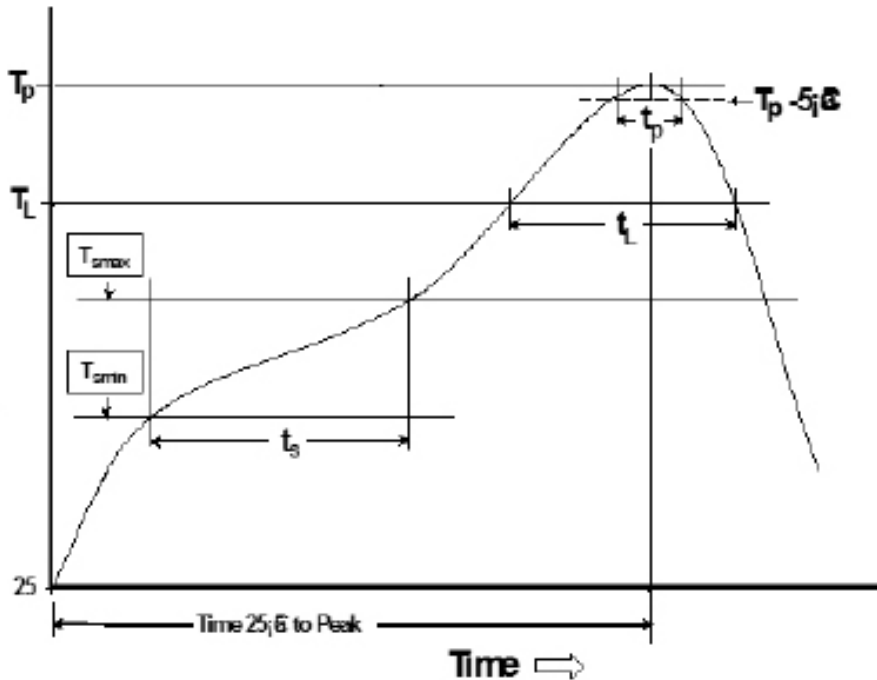

$T_{SMIN}$ (°C)	$T_{SMAX}$ (°C)	$T_L$ (°C)	$T_P$ (°C MAX)	$t_s$ (s)	$t_L$ (s)	$t_p$ (s MAX)	Ramp-up rate ( $T_L$ to $T_P$ )	Ramp-down rate ( $T_P$ to $T_L$ )	Time 25°C to peak temperature (s MAX)
100	150	183	235	60-120	60-150	20	3°C/s MAX	6°C/s MAX	360

Notes:

1. All temperatures measured on the package leads.
2. Maximum times of reflow cycle: 2.

For More Information

PulseR North America  
Headquarters

Two Pearl Buck Court  
Bristol, PA 19007  
U.S.A.

Tel: +1.215. 781. 6400  
Fax: +1.215. 781. 6403

For Global Sales Representative and Locations Visit:  
<http://www.pulseruggedized.com>

Performance warranty of products offered on this data sheet is limited to the parameters specified. Data is subject to change without notice. Other brand and product names mentioned herein may be trademarks or registered trademarks of their respective owners. © Copyright, 2018. PulseR,LLC. All rights reserved.